

CE 0413



CDRPanX User Guide

Schick Technologies, Inc.
30-30 47th Avenue
Long Island City, NY 11101
USA

(718) 937-5765
(718) 937-5962 (fax)

PART NUMBER B1051407 REV. A

Copyright © 2008 by Schick Technologies, Inc.
All Rights Reserved

CDR is a registered trademark of Schick Technologies, Inc and is covered by US Patent Numbers 5,912,942 and 6,134,298. Additional patents are pending.

Trademark designations used by other manufacturers and sellers may appear in this document also. Where Schick Technologies, Inc. was aware of a trademark claim, that information has been printed in caps or initial caps.

August 18, 2008



Printed in the United States of America

This document was originally prepared in English

Contents

1. Introduction	1
1.1. Purpose.....	1
1.2. Indications for Use.....	1
1.3. Notice to Installers	1
1.4. Notice to Users.....	2
2. General Information	3
2.1. System Description	3
2.2. System Operation.....	3
2.3. Control Panel	6
2.4. Control System.....	8
3. Installation	13
3.1. General.....	13
3.2. Requirements	13
3.3. iPan HS Interface Driver Installation.....	14
4. Controls and LED Indicators.....	18
4.1. iPan HS USB Interface	18
5. Operation	20
5.1. Turning On the System	20
5.2. Ready / Not Ready Indications	20
5.3. Turning Off the System	21
6. Panoramic Imaging.....	22
6.1. Panoramic Projection and Technique Factors.....	22
6.2. Patient Positioning and Panoramic Imaging	23
6.3. Using the Resend Option	25
6.4. Focal Trough Adjustments.....	27
6.5. TMJ Projections.....	28
6.6. Maxillary Sinus Projections.....	29
6.7. Operator Positioning and Panoramic Exposures.....	31
7. Using the iPan HS Upgrade Utility	32
7.1. Introduction.....	32
7.2. USB Interface Test.....	33
7.3. USB Interface Firmware Upgrade	34
7.4. Sensor Module Firmware Upgrade.....	35
8. Cleaning.....	36
8.1. CDRPanX Unit	36
8.2. iPan HS USB Interface	36
9. Maintenance.....	37

9.1. Visual Inspection	37
9.2. Periodic Maintenance.....	37
9.3. Scheduled Maintenance	38
Appendix A. Error Codes	39
Appendix B. Technical Data.....	40
Appendix C. Cooling Curves	44
Index.....	45

List of Figures

Figure 1. Panoramic Imaging Area	1
Figure 2. CDRPanX Simplified Block Diagram	3
Figure 3. CDRPanX (Patient View)	4
Figure 4. CDRPanX (Operator View)	5
Figure 5. CDRPanX Control Panel	6
Figure 6. Correct Beam Alignment for Mid-Sagittal, Frankfort, and Lateral Planes	12
Figure 7. Correct Beam Alignment for Frankfort and Lateral Planes	12
Figure 8. iPan HS USB Interface	18
Figure 9. Location of CDRPanX Power, Exposure, and Alignment Controls	20
Figure 10. Resend Option Selected in Panoramic Settings	25
Figure 11. Examples of Correct and Incorrect Patient Positioning	26
Figure 12. Displayed Focal Trough Adjustments.....	27
Figure 13. Examples of TMJ and Maxillary Sinus Exposures and Positioning	30
Figure 14. Operator Safety Zone	31
Figure 15. iPan HS Upgrade Utility	32

List of Tables

Table 1. CDRPanX Control Panel Description	6
Table 2. CDRPanX Exposure Switch Description	8
Table 3. Rotation Unit Positions and READY Light Indications.....	9
Table 4. iPan HS USB Interface LED Indications	19
Table 5. Voltage and Current Settings Based on Patient Type.....	22
Table 6. Control Panel Error Codes	39
Table 7. Summary of CDRPanX Technical Data.....	40
Table 8. Compliance Specifications	40
Table 9. Guidance and Manufacturer's Declaration - Electromagnetic Emissions	41
Table 10. Guidance and Manufacturer's Declaration - Electromagnetic Immunity	41
Table 11. Recommended Separation Distance Between Portable and Mobile RF Communications Equipment and the CDRPanX System	43

Safety Issues

CAUTION: Federal law restricts this device to sale by or on the order of a dentist licensed by the law of the State in which that person practices.

Equipment to be Operated and Serviced by Qualified Personnel Only

X-ray equipment produces ionizing radiation that may be harmful if not properly regulated. It is therefore recommended that the equipment be operated by trained and qualified personnel only, in accordance with all applicable local and federal regulations.

Only trained and qualified technicians are authorized to service this equipment. Power supply lines must comply with safety legislation and have ground terminals for protective earth connection. Always switch the equipment off and, if possible, disconnect it from main power supply before cleaning or disinfecting the system.

Protecting CDRPanX Equipment from RF Interference

Although the CDRPanX equipment is designed to provide a reasonable degree of protection from electromagnetic interference, according to IEC International regulations, it must be installed at an adequate distance from electricity transformer rooms, static continuity units, two-way amateur radios and cellular phones. To ensure proper operation, the latter can be used only at a minimum distance of 6 feet (1.8m) from any part of the equipment.

Any instrumentation or equipment for professional use located near CDRPanX must conform to Electromagnetic Compatibility regulations. Non-conforming equipment, with known poor immunity to electromagnetic fields, may not operate properly unless they are installed at a distance of at least 10 feet (3m) and supplied by a dedicated electric line.

Exercise Caution Near and Around Moving Parts

The Vertical Carriage and Rotation unit move during patient setup and panoramic exposure procedures. Operators must take appropriate precautions for themselves and their patients to prevent accidental injury during equipment operation.

Apply Recommended Procedures for Cleaning the Equipment

Safe and proper operation of the equipment requires that a regular schedule of preventive maintenance be followed. Refer to the Cleaning and Maintenance sections of this manual for details.

Do Not Connect Items that are Not Part of the System

Only items specified for use with the equipment are to be connected to the system. The equipment should not be used adjacent to, or stacked with, other equipment that is not part of the system. If, however, use with adjacent equipment is necessary, normal operation should be observed and verified in that configuration.

Installers to Ensure that the CDRPanX System Operates Optimally

Installers must ensure that the CDRPanX system, when installed, provides the user with the optimal use of the equipment. This includes, but is not limited to, ensuring the system operates in the temperature and humidity range specified in this document. Installers must also ensure that the system presents no physical obstacles or hazards during operation and when not in use. To verify this requirement, installers shall confirm that the CDRPanX system is installed as described in the Installation / Service Guide and shall perform the appropriate procedures therein.

Take Appropriate Precautions during CDRPanX Operation

Appropriate accessories, such as lead aprons, must be used, where necessary, to protect the patient and the operator from radiation.

The CDRPanX system has been determined to be in accordance with international safety standards and is deemed suitable for use within the patient area, which extends from the patient for a distance of 5 feet (1.5m). Outside the patient area, the presence of approved non-medical grade equipment and Listed / Approved / Certified Information Technology Equipment (ITE) computer equipment is acceptable.

Preventive Maintenance

There are no customer-serviceable components in the CDRPanX system. However, before operating the system, customers shall check it for any signs of physical damage or defect. If detected, contact your local distributor of Schick Technologies products for further instructions.

When No Longer Usable, Dispose of System Components Properly

The CDRPanX system is made of a variety of materials, including iron, aluminum, lead, copper, plastics, electronic components, and dielectric oil in the Tube head. Once the system is removed permanently from service, such components cannot be abandoned in the environment. They must be disposed of in accordance with applicable local regulations.

Ensure Proper System and PC Workstation Installation and Operation

CDRPanX has been determined to be in accordance with international safety standards and is deemed suitable for use within the patient area, which extends from the patient for a distance of 5 feet (1.5m). To comply with these standards, do not operate non-medical equipment (such as a PC workstation) inside the patient area. Outside the patient area, the presence of approved non-medical grade equipment and Listed / Approved / certified Information technology Equipment (ITE) computer equipment is acceptable.

The PC workstation that connects to the CDRPanX via compatible USB cable is an integral part of a Medical Electrical System. The PC must be a CE-approved computer system conforming with the Low Voltage [73/23/EC] and EMC Directive [89/336/ERC]. Also, to help ensure optimal performance, ensure that all software programs residing on

the workstation are virus-free and have been adequately tested so they will not impact imaging applications after installation.

Please refer to documentation provided by the PC manufacturer for important information about its safe operation and usage.

Use Only Dedicated Host Computer(s) for Imaging Application(s)

The host computer should be dedicated to imaging and not for general computing use. Also, prior to installing any software on dedicated workstation(s) and / or server(s), ensure that such software is virus-free and will not impact the operation and performance of imaging applications after installation.

Do Not Touch Exposed Connectors on Non-Medical Equipment and the Patient at the Same Time

When the CDRPanX product is in use, avoid touching exposed connectors on non-medical electrical equipment and the patient at the same time. The human body is capable of conducting electrical current and may cause a shock hazard to patients if appropriate safety practices are not observed.

Only Dentists or Authorized Designees Are Permitted to Operate the System

To ensure the correct use of CDRPanX in a clinical environment, for purposes that correspond to its intended design and application, only dentists, or their designees, are authorized to operate the system.

Use Only Manufacturer-Specified Parts and Accessories for Replacement











Using accessories, transducers, and cables, other than those specified by the Schick Technologies as appropriate replacement parts for internal components, may result in increased emissions or decreased immunity of the CDRPanX system.











The following cable configurations have been specified for the CDRPanX system.

SYSTEM COMPONENT	CABLE DESCRIPTION	CABLE ROUTED TO
CDRPanX USB Sensor	CAT-5	iPan HS USB Interface
iPan HS USB Interface	USB	USB port of compatible laptop or desktop PC

Symbols

Refer to the following table for symbols found on the CDRPanX itself, on the shipping packaging, or in text of this or other documents provided with the system.

SYMBOL	DESCRIPTION
	Indicates Class II Equipment
	Indicates Type B equipment in accordance with applicable medical device safety standards (IEC/EN/UL 60601-1)
	Indicates an attention to users to consult accompanying documents for more information
	Indicates that the product complies with EC Directive 93/42/EEC concerning Medical devices (European Community)
	Indicates that this product meets North American safety standards. The ETL mark is a Nationally Recognized Testing Lab (NRTL) marking and indicates conformance with UL 60601-1 and CAN/CSA STD C22.2 NO 601.1-M90
	Indicates that in the European Union, at the end of product life this device must be disposed of in accordance with the requirements of the Waste Electrical and Electronic Equipment (WEEE) directive 2002/96/EC
	Indicates that under certain ambient environmental conditions (especially low humidity), this device may be susceptible to electrostatic discharge (ESD). Appropriate care and handling must be observed to avoid damage.
	Green LED located on the iPan HS USB Interface. Displays status as Sensor transmits images to the iPan HS USB Interface.
	Orange LED located on the iPan HS USB Interface. Displays status as iPan HS USB Interface transmits images to the host computer.
	Warning, Read Carefully

SYMBOL	DESCRIPTION
	Warning, Electrical Shock
~	Alternating Current
	Protective Earth (Ground)
	Power Off (system disconnected from main power supply)
	Power On (system connected to main power supply)
	Radiography Push Button
	Ionizing Radiation Indicator
	Inherent Filtration
	Fragile, Handle With Care
	Humidity Limitation
	This End Up, Do Not Turn Over
	Stacking Limit

Label Locations

System Label (115V Shown)

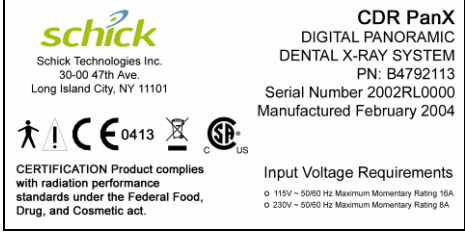
Label	Location
 <p>CDR PanX DIGITAL PANORAMIC DENTAL X-RAY SYSTEM PN: B4792113 Serial Number 2002RL0000 Manufactured February 2004</p> <p>Input Voltage Requirements <input type="radio"/> 115V - 50/60 Hz Maximum Momentary Rating 16A <input type="radio"/> 230V - 50/60 Hz Maximum Momentary Rating 8A</p>	<p>Located near the patient handles</p>

Fuse Label

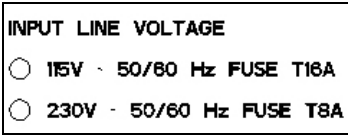
Label	Description
 <p>INPUT LINE VOLTAGE</p> <p><input type="radio"/> 115V - 50/60 Hz FUSE T16A</p> <p><input type="radio"/> 230V - 50/60 Hz FUSE T8A</p>	<p>Located near the fuse holder on the Vertical Carriage</p>

Generator Label

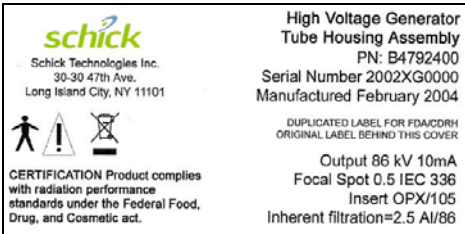
Label	Location
 <p>High Voltage Generator Tube Housing Assembly PN: B4792400 Serial Number 2002XG0000 Manufactured February 2004</p> <p>Output 86 kV 10mA Focal Spot 0.5 IEC 336 Insert OPX/105 Inherent filtration=2.5 Al/86</p>	<p>Located near the X-ray source (also duplicated label)</p>

X-ray Warning Label

Label	Location
<div style="border: 1px solid black; padding: 5px; width: fit-content; margin: auto;"> <p>WARNING This x-ray unit may be dangerous to patient and operator unless safe exposure factors and operating instructions are observed</p> </div>	<p>Located on the Vertical Carriage</p>

Collimator Label

Label	Location
<div style="border: 1px solid black; padding: 5px; width: fit-content; margin: auto;"> <p>Schick Technologies Inc. Long Island City, NY USA</p> <p>CDR PanX Collimator PN: B4792500 Serial Number 1909LD0000 Manufactured September 2003</p> <p>CERTIFICATION Product complies with radiation performance standards under the Federal Food, Drug, and Cosmetic act.</p> </div>	<p>Located on the Rotation unit and duplicated label near the X-ray Collimator</p>

Laser Label

Label	Location
<div style="border: 1px solid black; padding: 5px; width: fit-content; margin: auto;">  <p>Schick Technologies Inc. Long Island City, NY 11101 USA</p> <p>CDR PanX Laser Alignment System FDA Class 1 PN: B4792421 Manufactured February 2004 by SchkPanCo</p> <p>COMPLIES WITH FDA PERFORMANCE STANDARDS FOR LASER PRODUCTS CODE OF FEDERAL REGULATIONS CHAPTER 21 PARTS 1040.10 AND 1040.11</p> <p>Median Source PN A4505900 Lateral Source PN A4505900 Frankfurt Source PN A4505900</p> </div>	<p>Located near the patient handles</p>

Column Label

Label	Location
<div data-bbox="469 373 732 485" style="border: 1px solid black; padding: 5px; width: fit-content; margin: auto;"> <p>CDR PanX Column Assembly PN: B4792310 Serial Number 1909SC0000 Manufactured September 2003 Schick Technologies Inc., LIC, NY USA</p> </div>	<p>Located near the base of the Column</p>

Self Standing Base Label

Label	Location
<div data-bbox="469 772 732 884" style="border: 1px solid black; padding: 5px; width: fit-content; margin: auto;"> <p>CDR PanX Self Standing Base PN: B4792220 Serial Number 1909SB0000 Manufactured September 2003 Schick Technologies Inc., LIC, NY USA</p> </div>	<p>Located on the Self-Standing Base, near the Column</p>

iPan HS USB Interface

Label	Location
<div data-bbox="391 1192 810 1404" style="border: 1px solid black; padding: 10px; width: fit-content; margin: auto;">  <p>Conforms to UL Std. 60601-1. Certified to CAN.CSA C22.2 NO.601.1 iPan HS INTERFACE Input: +5VDC @ 250mA P/N B4855100 MFR XX/XXXX S/N XXXXX SCHICK TECHNOLOGIES, INC. L.I.C., NY 11101</p> </div>	<p>Regulatory Markings and Manufacturer Label (located on bottom)</p>

Waste Electrical and Electronic Equipment

Background

The European Union's Waste Electrical and Electronic Equipment Directive (2002/96/EC) has been implemented in member states. This directive, which seeks to reduce the waste of electrical and electronic equipment through re-use, recycling, and recovery, imposes several requirements on producers. Schick Technologies and its Dealers are committed to complying with the Directive.

WEEE Marking

All Schick products subject to the WEEE Directive will be compliant with the WEEE marking requirements. These products will be identified with the "crossed-out wheeled bin" WEEE symbol shown below, as defined in European Standard EN 50419, and in accordance with WEEE Directive 2002/96/EC.



This "crossed-out wheeled bin" symbol on the product or on its packaging indicates that this product must not be disposed of with other unsorted municipal waste. Instead, it is user's responsibility to dispose of EEE waste equipment by handing it over to a designated collection point for the reuse or recycling of waste electrical and electronic equipment. The separate collection and reuse or recycling of Electrical & Electronic waste equipment will help to conserve natural resources and ensure that it is recycled in a manner that protects the environment and human health. For more information about where you can drop off your waste equipment for recycling, please contact your local officials.

Reporting

According to the WEEE Directive, Schick Technologies or its Dealers will ensure that information needed to calculate the financial obligations with respect to EEE products will be provided as required.

WEEE from Users other than Private Households

According to the WEEE Directive, Schick Technologies or its Dealers will fulfill its obligations for the management of WEEE from users other than private households.

Furthermore, as required by the WEEE Directive, in order to enable the date upon which the equipment was put on the market to be determined unequivocally, a mark on the equipment will be placed to specify when the equipment was put on the market.

Information for Reuse Centers, Treatment and Recycling Facilities

As required by the WEEE Directive, Schick Technologies or its Dealers will provide reuse, treatment, and recycling information for each type of new EEE put on the market within one year of the date in which the equipment is put on the market.

Information will include the different EEE components and materials as well as the location of substances in these items. The information will be provided as a printed document or in electronic media (on CD-ROM or by web download, for example)

This page intentionally left blank

1. Introduction

1.1. Purpose

CDRPanX is a digital panoramic X-ray device, representing the latest technology in dental panoramic X-ray equipment. CDRPanX performs panoramic examinations for adults, children, left side of dentition, right side of dentition, anterior part of dentition, TMJ, mouth open and closed, and anterior view of nasal (maxillary) sinuses.

1.2. Indications for Use

CDRPanX is intended for individuals requiring extra-oral dental exams. It exposes and acquires radiographic images at the dento-maxillofacial region (**Figure 1**).

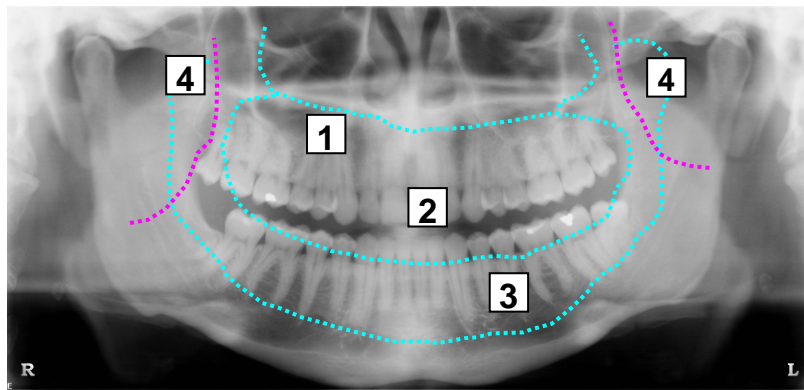

Figure 1. Panoramic Imaging Area

(1) Maxillary Region, (2) Dental Arch, (3) Mandibular Region, (4) Temporo Mandibular Joints (TMJ)

1.3. Notice to Installers

It is the responsibility of the Installer:

- To make sure that the line voltage specified by the manufacturer of the equipment is available and within the specified range
- To verify that a proper switch is available to disconnect the equipment from main power supply when needed during installation
- To install and test the equipment according to the CDRPanX Installation and Service Guide and other documentation, as needed.
- To provide the User Guide to the user.

1.4. Notice to Users

It is the responsibility of the User:

- To operate the system following the instructions and recommendations contained in this User Guide and in other related documentation provided with, or intended for, the operation and maintenance of the CDRPanX system.
- To maintain the equipment by complying with the maintenance schedule described in this document. Failure to maintain the equipment properly may result in personal injury or equipment damage and may relieve the manufacturer, or its designated agent, from responsibility arising from injury, damage, or non-compliance.
- To report promptly to the appropriate authority and the manufacturer, or its designated agent, any accident involving this medical device or any alteration in features and / or performance that could constitute a health hazard to the patient and / or operator. Information about your particular CDRPanX system can be found on the system itself, on labels described in this manual.

2. General Information

2.1. System Description

The CDRPanX system consists of the following hardware: CDRPanX panoramic machine, iPan HS USB Interface, and associated cables. A simplified diagram of the CDRPanX system is provided below.

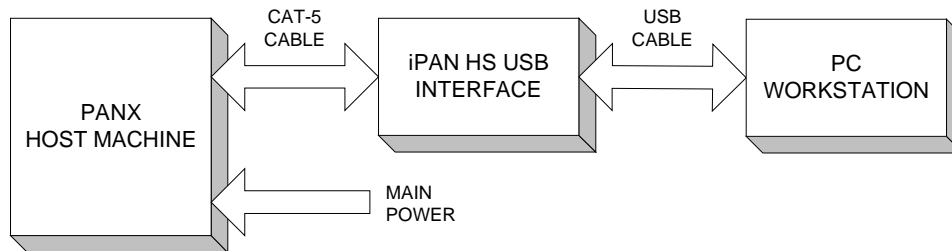

Figure 2. CDRPanX Simplified Block Diagram

The following accessories are applicable to the CDRPanX system and are used for support during panoramic imaging.

- A4505000 Bite Block
- A4505200 Edentulous Lip Support
- A4505300 TMJ / Sinus Lip Support.

2.2. System Operation

Panoramic imaging is performed by means of a narrow X-ray beam that scans the dento-maxillofacial area of the patient. To ensure that this region is represented optimally on the resulting image, proper understanding of the CDRPanX equipment and patient positioning is required. **Figure 3** and **Figure 4** provide the location and identification of patient and operator views of the CDRPanX system.

The CDRPanX system requires the following software and compatible operating systems:

- CDR DICOM for Windows 4.5 and higher, EagleSoft 14.0 and higher, or Patterson Imaging 14.0 and higher Windows XP Professional or Windows 2000
- Windows Vista (Home Premium, Business, or Ultimate), XP Professional, or Windows 2000 Professional
- iPan HS Interface Driver (provided with the iPan HS system).

This User Guide is one of two documents needed to install the CDRPanX system completely. Before performing the procedures in this document, you or a qualified service technician should complete the steps in the Installation Guide (B1051408).

All of the procedures for installing CDRPanX hardware may be found in your Installation Guide. Procedures for installing the iPan Interface driver can be found in this User Guide (**Section 3.3**).

Refer to **Figure 3** for the following references.

CDRPanX consists of the following principal parts. A Vertical Carriage (**1**), to which the power supply cord, Exposure switch, and digital imaging cable are connected, moves vertically along the Column (**2**), permitting adjustments for the height of the patient. A Rotation unit (**3**), consisting of a Control Panel (**4**), Digital Image Sensor system (**5**), and X-ray Tube head (**6**), is connected to the Vertical Carriage.

When positioning the patient for panoramic images, adjust the Rotation unit for patient access, making the proper adjustments to ensure good panoramic images. (Additional information on positioning may be found on **Table 3** and in **Section 6.2**.)



Figure 3. CDRPanX (Patient View)

Refer to **Figure 4** for the following references.

For proper patient positioning, use the pushbutton on the Control Panel to activate the laser alignment beams — Mid-Sagittal Plane (1), Frankfort Plane (2), and Lateral Plane for the center of the Focal Trough (3).

Instruct the patient to grasp the patient handles (4) during the setup procedure as this will help maintain correct positioning, even after the alignment adjustments are made. The adjustment Knob (5) and Scale (6) are used during patient setup to change the distance between the Bite Block (7) and the Vertical Carriage. Magnetic Brake button (8) is used with the Handle (9) to adjust the Rotation unit vertically, along the Column.

Also accessible from the side of the CDRPanX are the Exposure switch (10) and connector (11), On / Off switch (12), and AC cable (13) for electrical service to the unit.

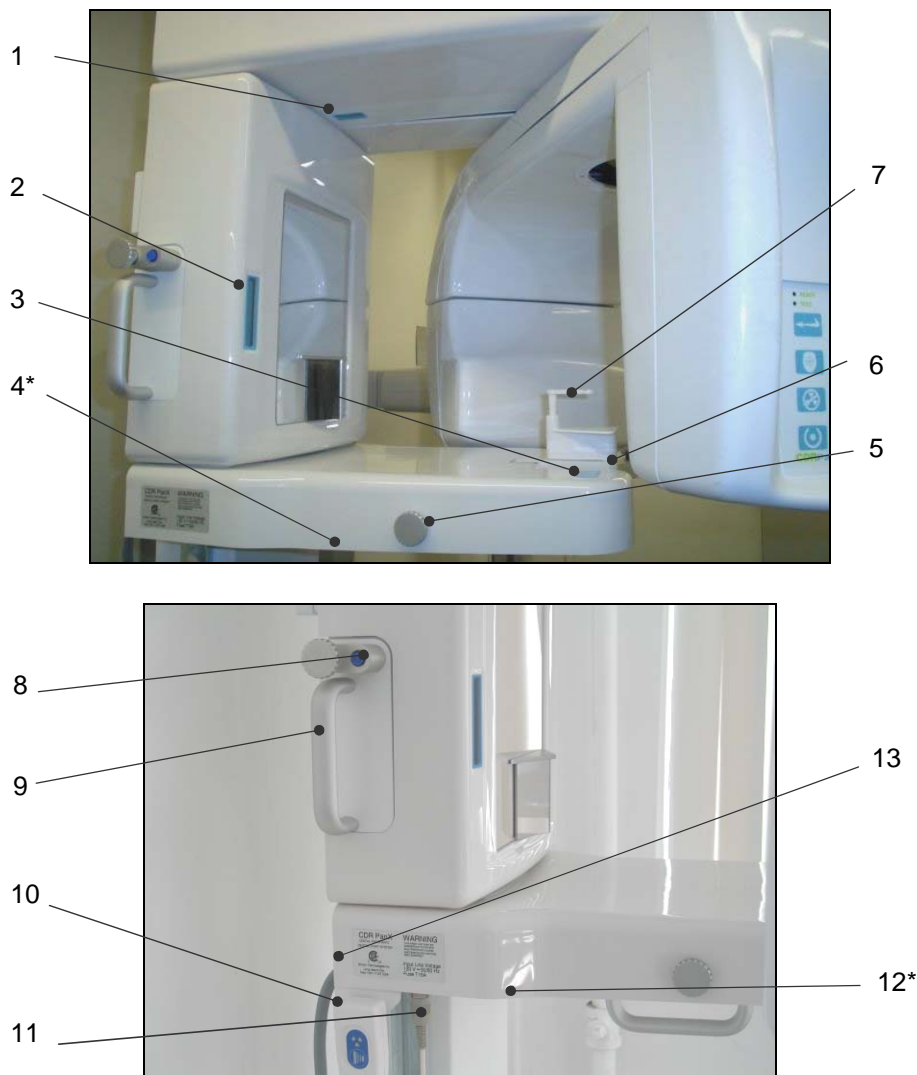

Figure 4. CDRPanX (Operator View)

(Locations of Asterisked Items are Approximate)

2.3. Control Panel

Descriptions of Control Panel pushbuttons and indicators can be found by referring to **Figure 5** and **Table 1** that follows.

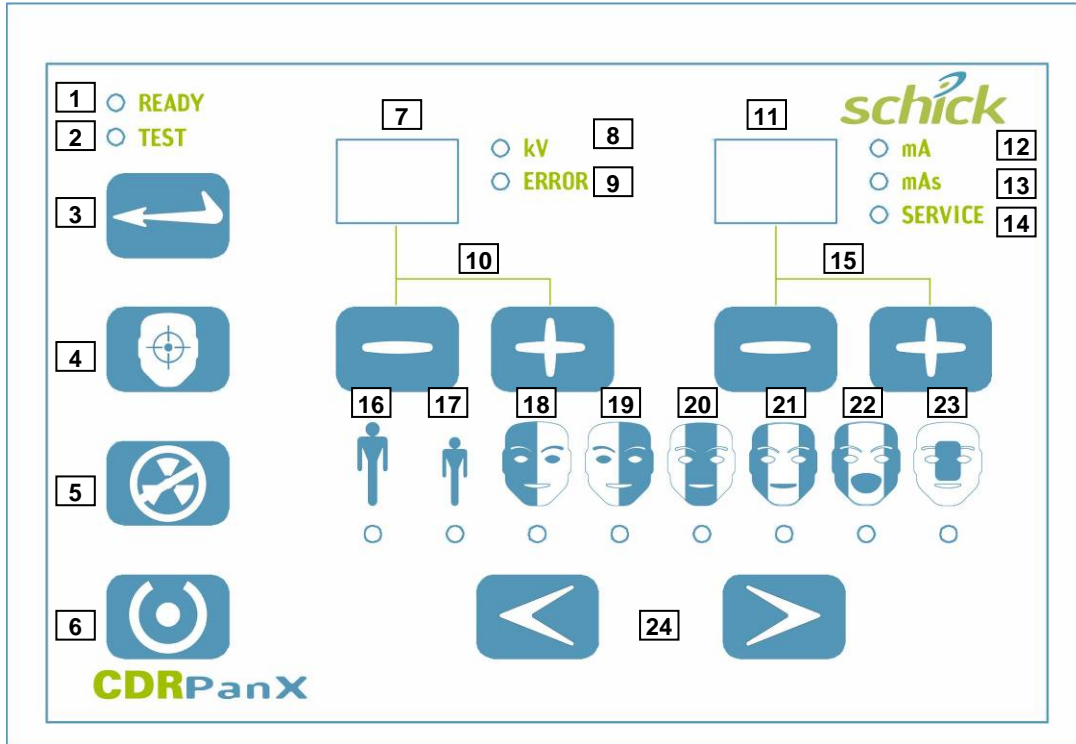





Figure 5. CDRPanX Control Panel

Table 1. CDRPanX Control Panel Description

No.	Item	Description	Additional References
System Pushbuttons and Indicators			
1	READY	Indicates that system is ready to take an X-ray	—
2	TEST	Indicates test status condition is on / off	—
3		Returns Rotation unit to ready position and resets errors	—
4		Activates the laser alignment beams for 15 seconds	—
5		Rotation Test - Operates system without X-ray source active	—















No.	Item	Description	Additional References
6		Resets system to initial settings	—
kV Pushbuttons and Indicators			
7	kV	kV and Error code display	—
8	kV	kV indicator	Tube voltage displayed in Item No. 7
9	ERROR	Error status indicator	Error code displayed in Item No. 7
10		Decrease (-) or increase (+)	Adjusts value displayed in Item No. 7
mA and mAs Pushbuttons and Indicators			
11	mA / mAs	mA /mAs and Service code display	—
12	mA	mA Indicator	Tube mA value displayed in Item No. 11
13	mAs	mAs Indicator	mAs value displayed in Item No. 11
14	SERVICE	Service Indicator	Service code displayed in Item No. 11
15		Decrease (-) or increase (+)	Adjusts value displayed in Item No. 11
Panoramic Program Pushbuttons and Indicators			
16		Adult selected	—
17		Child selected	—
18		Left side of dentition selected	—
19		Right side of dentition selected	—
20		Anterior part of dentition selected	—
21		TMJ selected: mouth closed	—
22		TMJ selected: mouth open	—
23		Anterior view of nasal (maxillary) sinuses selected	—
24		Program selection	Selects program displayed in Items Nos. 16 to 23

Table 2. CDRPanX Exposure Switch Description

Item	Description	Additional References
	Initiates X-ray exposure	—
	Illuminates when X-rays are being emitted	—

2.4. Control System

2.4.1. Setup for Exposure

IMPORTANT! Never move the Rotation Unit manually as permanent damage to the CDRPanX system may result. To reset or reposition the Rotation Unit, ALWAYS use the Exposure switch with the system in TEST mode.





The Rotation unit can be at rest in one of four positions:

1. Patient Entry Position – Rotation unit at rest with the Control Panel on the left, X-ray generator on the right (when viewed facing the mirror).
2. Ready Position – Rotation unit positioned at rest at the start of its travel waiting for start of exposure.
3. End of Exposure Position – Rotation unit at rest at the end of its travel at the completion of an exposure.
4. Patient Exit Position – Rotation unit at rest with the Control Panel on the right, X-ray generator on the left (when viewed facing the mirror).

The Return button on the Control Panel or the Exposure switch is used to initiate the positioning of the Rotation unit. Assuming the Rotation unit is at the Patient Exit position from a prior exposure, momentarily pressing either the Return button or Exposure switch sends the Rotation unit to the Patient Entry position.

The following table describes the various positions of the Rotation Unit during system operation and can be used for reference in the paragraphs that follow.

Table 3. Rotation Unit Positions and READY Light Indications

Rotation Unit Position	Location	READY Indicator
Patient Entry		OFF
Ready		ON
Rotation / Scan Finished		BLINKING during X-ray Tube cooling cycle
Patient Exit		BLINKING during X-ray Tube cooling cycle

2.4.2. Exposure

After the patient is properly positioned in the machine, momentarily pressing either the Return button or Exposure switch again sends the Rotation unit to the Ready position. The READY indicator illuminates when the unit has reached the Ready position.

- A. To start exposing an image: Press the Exposure switch to initiate the exposure and keep the switch depressed during the entire travel of the Rotation unit. The yellow X-ray warning light on the Exposure switch will illuminate and an audible alarm will sound as X-rays are emitted.
- B. To stop an exposure immediately at any time: Release the Exposure switch, which terminates the exposure immediately. Interrupting an exposure illuminates the Error indicator and sounds an alarm. Pressing either the Return button or the Exposure switch extinguishes the Error indicator and silences the alarm. Pressing either button a second time moves the Rotation unit to the Patient Exit / Entry position.

2.4.3. Monitoring During Exposure

During the exposure, the Control System monitors movement of the Rotation unit and X-ray generation according to the selected projection.

2.4.4. Reset for Next Exposure

After the exposure the Rotation unit comes to rest at the End of Exposure position. Momentarily pressing either the Return button or Exposure switch at this time sends the Rotation unit to the Patient Exit position.

When the kV indicator is on, the X-ray tube anode voltage value is selected using Item 10, **Table 1**. The anode voltage can be set from 60 to 86 kV in steps of 2 kV.

2.4.5. Anode Current Setting

When the mA indicator is on, the X-ray tube anode current value is selected using Item 15, **Table 1**. The anode current can be set to 4, 5, 6.3, 8 or 10 mA.

2.4.6. Panoramic Projections

Program Selection buttons Item 24, **Table 1**, are used to select the desired panoramic projection. Adult and Child selections, Items 16 and 17, are used to select respectively longer or shorter exposure durations for full panoramic images. Please refer to Items 18 through 24 for available partial projections. Please refer to **Table 4** in **Appendix B** for exposure durations for the various projections.

2.4.7. Reset Function

CDRPanX is initialized each time the system is turned on and whenever the Reset pushbutton is pressed. Initializing the system performs the following actions:

- A. Sets the proper values for control signals, stops all motors, sets anode voltage to 60 kV, sets anode current to 8 mA, and selects the Adult Panoramic program.
- B. Performs system testing and displays any detected errors on the Control Panel.

2.4.8. Error Handling

In the event CDRPanX detects an error during operation or testing, the Error indicator on the Control Panel illuminates, accompanied by an error message code, and an audible alarm to alert the operator. The kV indicator is extinguished. To reset the system and clear the error condition, press the Return pushbutton or the Exposure switch.

2.4.9. Laser Alignment Beams

The laser alignment beams ensure proper patient positioning along three separate anatomical planes (**Figure 6** and **Figure 7**).



WARNING: The source of the alignment beams is a Class 1 Laser. Operators are advised to avoid exposing their eyesight and that of their patients to unnecessary laser radiation by positioning the patient correctly and limiting the number of times the alignment beams are activated.

2.4.10. Mid-Sagittal Plane

This is a vertical plane that is used to distinguish the right from left sides of the patient. When set correctly, the beam should bisect the patient's face.

2.4.11. Frankfort Plane

This is a horizontal plane that is used to distinguish the forward and backward orientation of the patient's head. When set correctly, the beam should follow a line emanating from the upper border of the tragus, running along the Zygomatic Arch, to the lower border of the orbit. Using the laser positioning beam as a guide, the operator should ensure that the patient's head is not tilted forward or back.

2.4.12. Lateral Plane

This is a vertical plane used to indicate the relationship of the Rotation unit to the patient. When the Rotation unit is set correctly, the patient's teeth and / or related structures will be exposed within the focal trough. The beam should be positioned interproximally between the lateral and canine teeth.

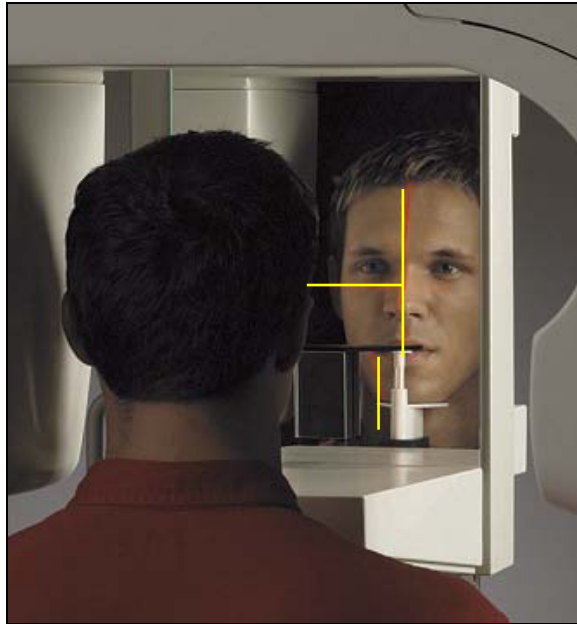

Figure 6. Correct Beam Alignment for Mid-Sagittal, Frankfort, and Lateral Planes

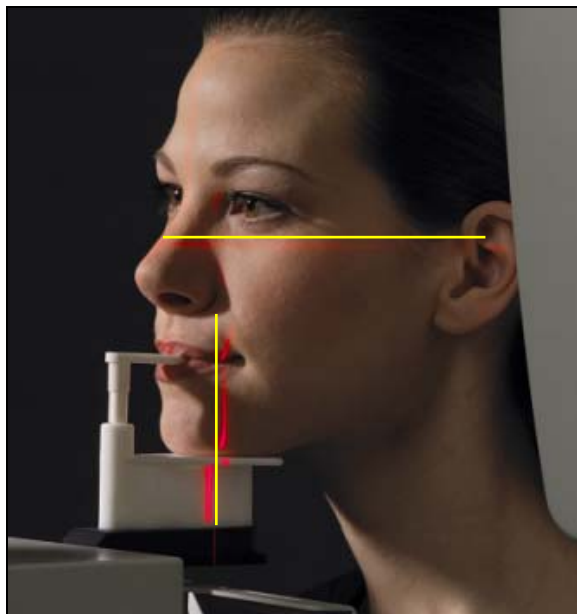

Figure 7. Correct Beam Alignment for Frankfort and Lateral Planes

(Laser Indications are Highlighted for Legibility on this Page and Elsewhere in this Document)

3. Installation

3.1. General

Perform the following procedures to install the iPan HS Interface hardware and software.

- Install iPan HS Interface Driver (**Section 3.3**)
- Start using your CDRPanX System

3.2. Requirements

The recommended system requirements for CDR DICOM workstations are:

- Compatible operating system (refer to **Section 2.2**)
- 512 MB RAM or higher
- Pentium IV 1 GHz or better or AMD 2 GHz or better
- 40 GB free disk space ¹

EagleSoft and Patterson Imaging customers should refer to their user documentation for details.

¹ Storage requirements will vary depending on the patient volume for each practice.

3.3. iPan HS Interface Driver Installation

Start driver installation

Perform the following steps to start installing the iPan HS Interface driver from CD.

Step	Action
1	Exit CDR DICOM, EagleSoft, or Patterson Imaging if running and verify that the iPan HS Interface is NOT connected to the computer.
2	Insert the iPan HS Interface Driver CD and click Install iPan HS Interface Driver when the start page is displayed.
3	If prompted, install Microsoft's .NET framework.
4	Click Next at the Welcome screen.

An example of the Welcome screen is shown below.



Continued on next page

Complete driver installation

Perform the following steps to install the iPan HS Interface driver on your system.

Step	Action
1	Click Install at the Ready to Install Screen.
2	Click Finish at the end of the Installation.

An example of the Ready to Install the Program (iPan HS Interface Driver) screen is shown below.

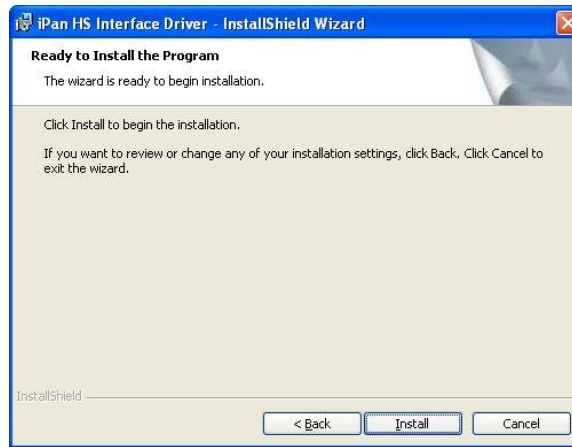

An example of the InstallShield Wizard completed screen (for installing the iPan HS Interface Driver) is shown below.



Continued on next page

Connect iPan HS Interface to computer

Perform the following steps to connect the iPan HS Interface to the computer.

Step	Action
1	Connect the iPan HS USB Interface to the computer using the supplied USB cable, which illuminates the amber LED.
2	If the Add New Hardware wizard starts and Windows asks to connect to Update, select “No, not this time” and click Next.
3	Click next when the wizard asks to install software automatically.
4	Click Finish and connect the CAT-5 cable to iPan HS interface.

An example of the Found New Hardware wizard is shown below.



An example of the Completing the Found New Hardware Wizard screen is shown below.



Continued on next page

Start iPan HS Upgrade Utility

Perform the following steps to start the iPan HS Upgrade Utility to ensure that you have the latest firmware.

Step	Action
1	For CDR DICOM, EagleSoft, Patterson Imaging customers, click Start > Programs > CDR DICOM for Windows > iPan HS Upgrade Utility.
2	When the iPan HS Upgrade Utility is displayed, verify that all version numbers are in green. If all version numbers are green, the latest firmware has been installed successfully.
3	If there are any items in the iPan HS Upgrade Utility with version information in red, these must be upgraded, by clicking on the button next to the item.

An example of the iPan HS Upgrade Utility is shown below. (Please note that the version numbers shown in the picture below are examples only and may differ from those reported for your system.)



4. Controls and LED Indicators

4.1. iPan HS USB Interface

The iPan HS USB Interface is connected by CAT-5 cable to the PanX host machine and by USB cable to a dedicated PC workstation. The iPan HS USB Interface provides several important functions, including Sensor diagnostics and field upgrades of firmware for the Sensor and the iPan HS USB Interface itself.

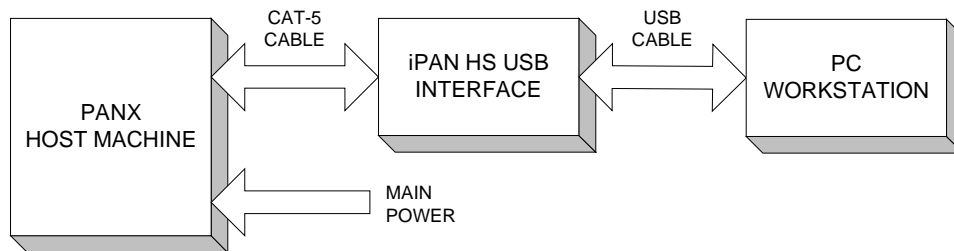

LEDs are located on the exterior of the iPan HS USB Interface and provide power and status information. A cable release access opening, located at the top of the device, can be used to disconnect the CAT-5 cable with the help of a small tool (like a screwdriver).

The illustration and table that follow provide additional details about the iPan HS USB Interface.

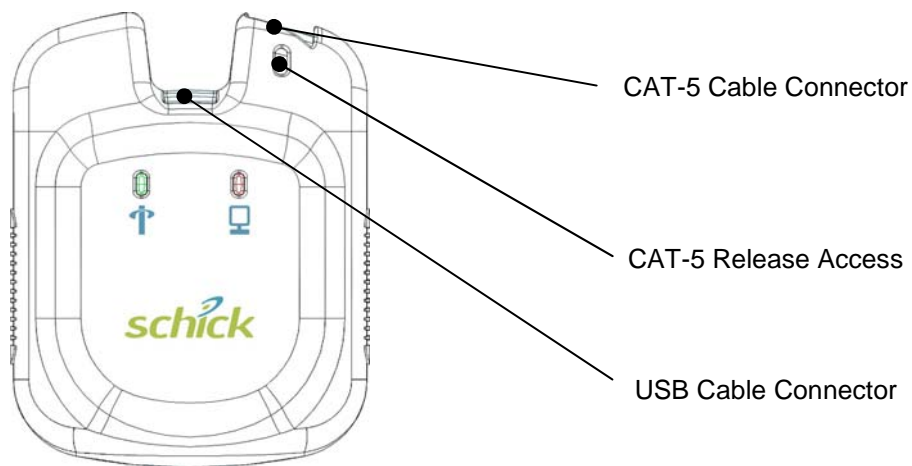



Figure 8. iPan HS USB Interface

Table 4. iPan HS USB Interface LED Indications

Green LED (Sensor)	Orange LED (iPan HS USB Interface)	Status
		
OFF	ON	USB cable connected, Sensor not detected
ON	OFF	Error condition
ON	ON	USB cable connected, Sensor detected
Blinking	—	Sensor is transmitting image to iPan HS USB Interface
—	Blinking	iPan HS USB Interface is transmitting image to host computer
OFF	OFF	USB cable not connected if CDR is running, or USB driver is not installed

5. Operation

5.1. Turning On the System

Please Note: CDRPanX must be operated only by personnel qualified to operate the equipment safely and correctly and with full knowledge of applicable laws and regulations.

Turn on power at the CDRPanX On / Off switch (**Figure 9**). Initial turn-on conditions are displayed at the Control Panel (**Figure 5**):

- X-ray Tube Anode voltage is 60kV
- X-ray Tube Anode current is 8 mA
- Adult Panoramic program is selected

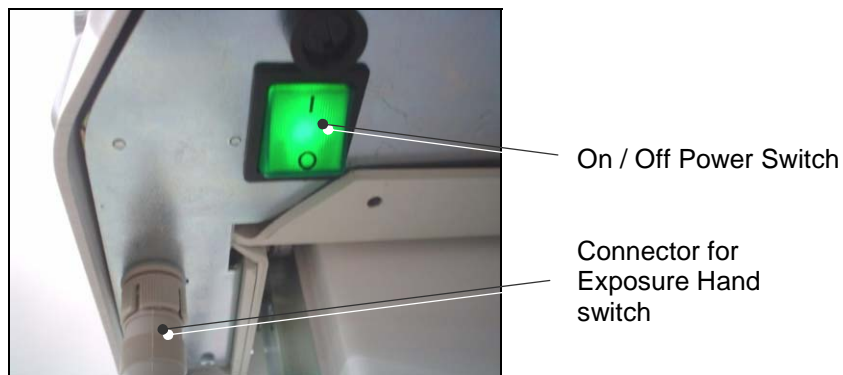

Figure 9. Location of CDRPanX Power, Exposure, and Alignment Controls

5.2. Ready / Not Ready Indications

Ready / Not ready indications are displayed at the Control Panel (**Figure 5**):

A. READY indicator is illuminated

The Rotation unit is in the Ready position and ready for movement. CDRPanX is considered ready for normal operation

B. READY indicator is blinking

After each exposure, this indication occurs automatically as the CDRPanX enters a waiting period during which the Tube head cools down (6 minutes, maximum). When the cooling cycle ends, the Ready indicator stops blinking and an audible alarm alerts the operator that usage can be resumed. During the period when the Ready indicator is blinking, only TMJ projections can be made; all other panoramic programs are unavailable.

C. READY indicator is not illuminated

Press the Exposure switch or Return pushbutton to perform the Return function.

5.3. *Turning Off the System*

Turn off power at the CDRPanX On / Off switch. When power is off, all indications at the Control Panel are extinguished.

6. Panoramic Imaging

6.1. Panoramic Projection and Technique Factors

Please Note: The CDRPanX can be operated without X-ray generation in TEST mode. This test, described in the following steps, is performed to convey the sequence for taking a panoramic X-ray and is suitable as either a training tool for practitioners or as a pre-exam demonstration for patients.

1. Start CDR software and create a new panoramic exam (refer to the CDR User Guide for details).
2. Select the appropriate exposure duration according to the patient's size by selecting either the Adult icon (Item 16, **Figure 5**) or the Child icon (Item 17).
3. Set the anode voltage and current using **Table 5** as a guide.
4. The CDRPanX can be operated without X-ray generation by pressing the Rotation Test pushbutton Item 5, **Table 1**. Pressing the Exposure switch under Test conditions causes the system to perform normally, except that X-rays are not generated. The TEST indicator on the Control Panel is illuminated and the kVp and mA displays are set to zero to indicate that X-rays are disabled in this mode.
5. Once the testing session has been completed, the Rotation unit can be brought to the ready position by pressing the Return pushbutton or the Exposure switch.
6. Pressing the TEST pushbutton again terminates test mode, extinguishes the TEST indicator, and restores the previous values to the kVp and mA displays. CDRPanX returns to normal status, ready to operate with X-ray emission.

Table 5. Voltage and Current Settings Based on Patient Type

Patient	X-ray Tube Anode Voltage (kV)	X-ray Tube Anode Current (mA)
Child (\pm 12 years)	66-68*	5
Female	68-70*-72	6.3
Male	70-72*-74	8

NOTE: Asterisked values (*) represent an average skeletal structure. Increases or decreases in the kV setting may be made depending on the actual skeletal size of the patient.

6.2. Patient Positioning and Panoramic Imaging

IMPORTANT! Proper setup procedures and correct patient positioning is essential for good panoramic images. For TMJ or Maxillary Sinus projections, refer to Sections 6.5 and 6.6, respectively. Examples of patient positioning are supplied in Figure 11.

Patient Evaluation

1. Ask the patient to remove any metal item (non-permanent denture, earrings, or necklace) that might cause ghost images on the radiograph. Start CDR and create / open an exam with at least one empty Panoramic viewbox. (Orange LED on the iPan HS USB Interface is illuminated, indicating that the device is powered on.)
2. If a protective apron is to be used, leave the neck area clear so as not to interfere with the X-ray beam (radiation is entering from sides and back of the patient). If the bite block is to be used, ensure that it is covered securely by a sheath.
3. At the Control Panel, select the proper kV and mA settings. Choose the appropriate projections and technique factors.
4. Examine and classify the patient's teeth, which will help determine the position of the bite block. Please note that in some cases, class I and class II teeth cannot be completely shown on a single panoramic image. For these patients, expose the upper or lower jaw first, then use the projection of the front teeth to represent the missed jaw, either upper or lower.
 - Class I (normal teeth): 0 mm shift
 - Class II (protruded teeth): 2 mm shift towards the vertical column
 - Class III (retruded teeth): 2 mm shift away from the vertical column
5. At the Control Panel, turn on the laser alignment beams. Verify that the Lateral beam displays interproximally between lateral and canine teeth. The Lateral beam identifies the center of the focal trough as described in **Figure 12**.

Patient Positioning

6. Walk the patient to the X-ray unit so he / she is facing the mirror and holding the lower handles firmly.
7. Raise the chin rest to slightly above the resting chin position. In this position, instruct the patient to bite in the middle part of the sheathed bite block.
8. Direct the patient's bite into the groove on the bite block so that the chin is resting on the chin holder and the patient can remain in a stable position.
9. Turn on the laser alignment beams again and re-verify correct positioning. The beams will remain on for 15 seconds and then turn themselves off automatically. If you need additional time for positioning, activate the beams again.

10. Instruct the patient to close his / her lips with the tongue relaxed against the palate. The patient should also move his / her feet forward, leaning on the handles slightly, stretching the spine.

Panoramic Image Exposure

11. Turn on the laser alignment beams again, verifying proper patient position (Lateral, Frankfurt, and Mid-sagittal planes) in preparation for image exposure.
12. Instruct the patient to remain still and look at the mirror facing him / her.
13. Press the Exposure switch to move the Rotation unit to the Ready position. The READY indicator illuminates.
14. At the computer, click on an empty Panoramic viewbox in a CDR exam. Ask the patient to: (a) swallow and keep the tongue lightly pressed to the palate, and (b) remain calm and avoid movement until the end of the exposure. *The CDRPanX machine will indicate Error Code 11 if the Panoramic viewbox is not selected prior to starting panoramic motion. To clear the error, press the Exposure switch momentarily.*
15. When the message, “Ready to acquire image . . . Activate panoramic motion now” appears, press the Exposure switch to initiate the exposure and keep the switch depressed during the entire travel of the Rotation unit. See **Section 6.7** for proper operator positioning during exposure. (When image data is being transferred from the iPan HS USB Interface to the PC, the Orange LED on the iPan HS USB Interface will blink.)
16. When the Rotation unit has completed its scan, press the Exposure switch once more. This will move the Rotation unit to its Exit / Entry position so the patient can exit easily.

6.3. Using the Resend Option

The Resend option retrieves the last acquired image from the buffer inside the Sensor and displays it in an empty viewbox that you select. This feature is appropriate when a corrupted image is displayed on a system that, otherwise, appears to be operating properly. In this instance, it may be possible to retrieve an uncorrupted version of the image directly from the Sensor, without having to expose the patient to additional X-rays.

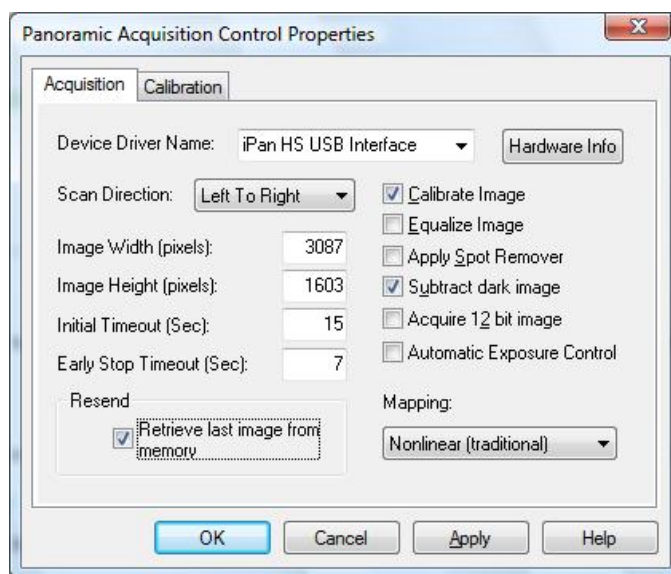
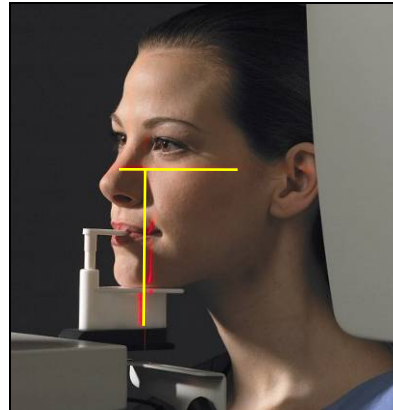

Figure 10. Resend Option Selected in Panoramic Settings

An example of how the Resend feature is used is provided below:

1. After taking a panoramic X-ray, a corrupted image is displayed.
2. **IMPORTANT!** Do not close CDR DICOM, EagleSoft, or Patterson Imaging as this will clear the image in the Sensor.
3. Locate the Resend option on the Panoramic device property page:
 - [CDR DICOM] System > Panoramic Settings.
 - [EagleSoft or Patterson Imaging] File > Preferences > X-ray > Schick Panoramic.
4. Mark the “Retrieve last image from memory” checkbox and click OK.
5. Click on an empty viewbox.
6. Click Yes to the message, “Do you want to resend the last acquired image?”
7. The image appears in the selected viewbox.

The Resend checkbox is cleared automatically after this function is used.



Correct position, Frankfort plane is horizontal

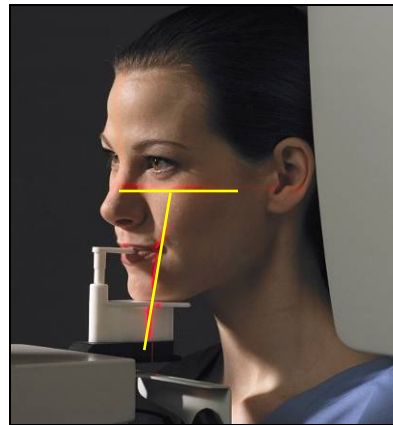
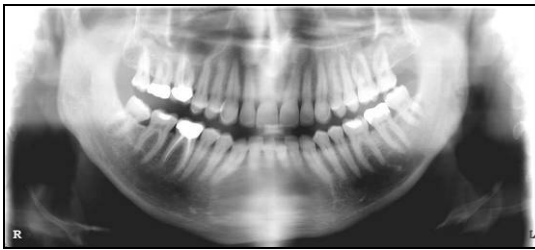

Wrong position, head tilted forward, V shaped dental arch

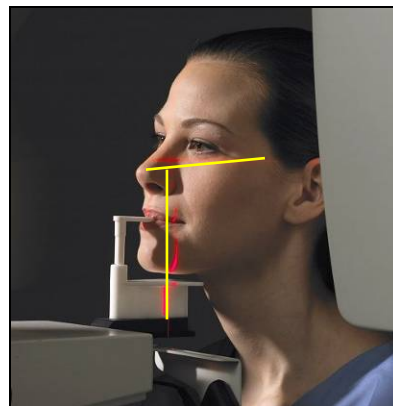
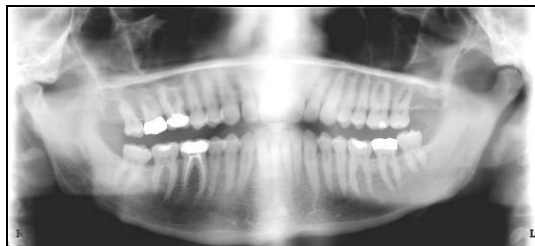

Wrong position; head tilted backward, flat dental arch

Figure 11. Examples of Correct and Incorrect Patient Positioning

6.4. Focal Trough Adjustments

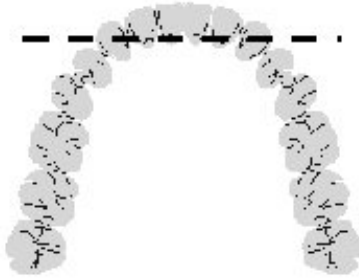

INDICATION: Precisely displayed focal trough. The laser beam is directed on the canine. The roots of the incisors are exactly in the center of the focal trough. Front teeth are displayed sharply.

No adjustment needed.

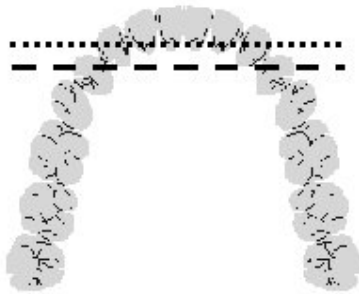

INDICATION: The laser beam (dash line) is posterior to the canine (dotted line).

PROBLEM: The roots of the incisors fall outside the focal trough. The front teeth appear blurred and proportionally narrower (reduction).

ADJUSTMENT: Use the Knob to move the patient backward (away from the Column) to correct.

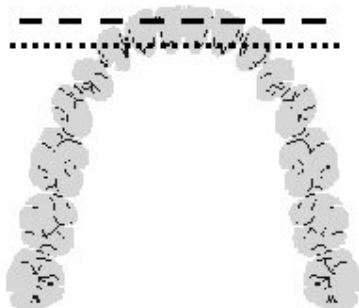

INDICATION: The laser beam (dash line) is anterior to the canine (dotted line).

PROBLEM: The roots of the incisors fall outside the focal trough. The front teeth appear blurred and proportionally wider (magnification).

ADJUSTMENT: Use the Knob to move the patient forward (towards the Column) to correct.

Figure 12. Displayed Focal Trough Adjustments

6.5. TMJ Projections

Position the patient for panoramic images (**Section 6.2**) and perform the following steps.

Please Note: When taking TMJ images, two exposures will each be displayed in their own viewbox.

1. Select the TMJ Closed Mouth projection on the Control Panel (Item 21, **Table 1**).
2. The chin support is below the nose. The patient is to have normal occlusion with closed mouth (**Figure 13**).
3. Increase X-ray tube voltage by 4 kV above what would be normally used for full panoramic images.
4. Adjust the lateral alignment beam approximately 0.6 in (15 mm) backwards — away from the column — when compared with a typical position for a panoramic image (on the external edge of the eye).

Please Note: In the following step, press and hold down the Exposure switch during the entire interval in which the Rotation unit is in motion. No radiation is emitted during the middle part of the movement and the audible alarm is cancelled.

5. Create a new CDR exam with 2 viewboxes. Click on the first viewbox, then press and hold the Exposure switch to take the image. The image displays in the first viewbox. CDRPanX advances automatically to the TMJ Open Mouth projection.
6. Press the Exposure switch or Return pushbutton to move the Rotation unit to the Patient Exit position. The patient may exit if the TMJ Open Mouth projection is not desired.
7. If the TMJ Open Mouth projection is desired, set Lateral beam 5mm forward / anteriorly from closed position. Ask the patient to open his / her mouth as wide as possible and check the position again. Press the Exposure switch or Return pushbutton again to return the Rotation unit to the Patient Entry position.
8. Press the Exposure switch or Return pushbutton again to move the Rotation unit to the Ready position. The Ready indicator will be lit
9. Click on another viewbox in CDR, then press and hold the Exposure switch to take the image. The image displays in the second viewbox.

6.6. Maxillary Sinus Projections

Position the patient for panoramic images (**Section 6.2**) and perform the following steps.

1. Select the nasal (maxillary) sinus projection on the Control Panel (Item 23, **Table 1**).
2. The chin support is below the nose. The patient is to have normal occlusion with closed mouth (**Figure 13**).
3. Increase X-ray tube voltage by 4 kV above what would be normally used for full panoramic images.
4. Set the focal trough by 1.1 in (30 mm) backwards — away from the Column — when compared with a typical position for a panoramic image.
5. Click on the appropriate viewbox in CDR, then press and hold the Exposure switch to take the image. The image displays in the viewbox.

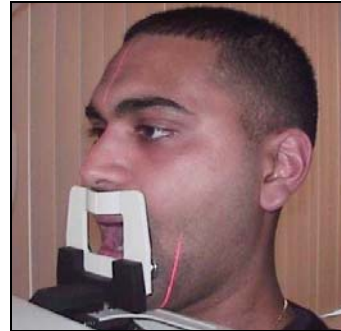
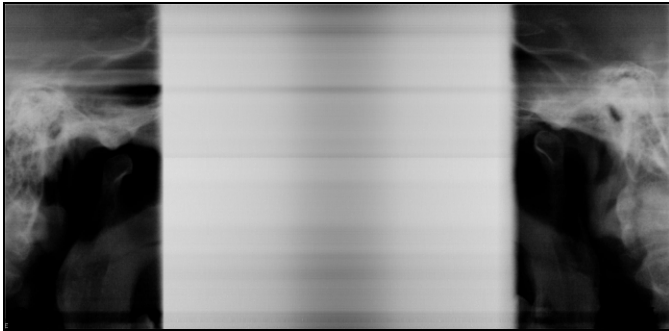
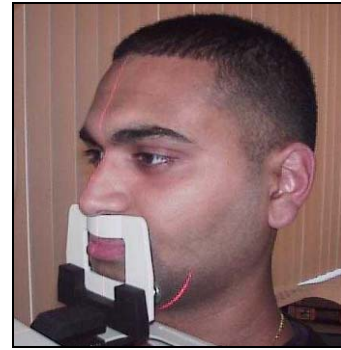
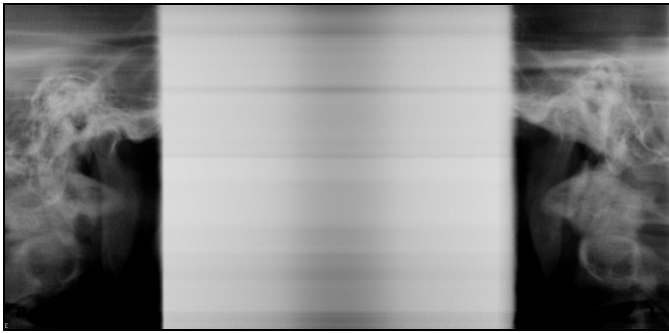

TMJ Exposures Closed (Top) and Open (Bottom)

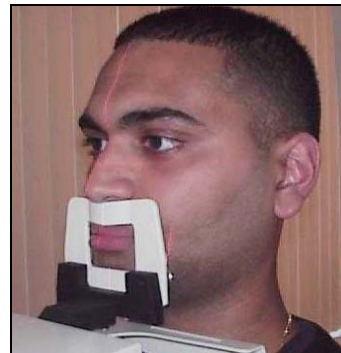
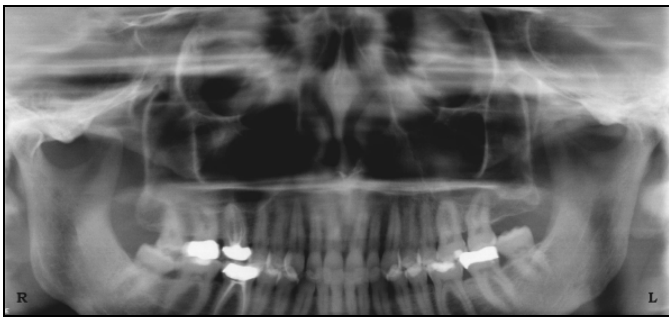

Maxillary Sinus Exposure

Figure 13. Examples of TMJ and Maxillary Sinus Exposures and Positioning

6.7. Operator Positioning and Panoramic Exposures

Please Note: Always observe the patient during examination and be ready to terminate the exposure, if necessary, at any time.

The proper position for the operator during panoramic exposures is:

- Behind the patient, 10 feet (3 meters) from the column (in the designated safe zone, as described in **Figure 14**), or
- Outside the exam area or operator.

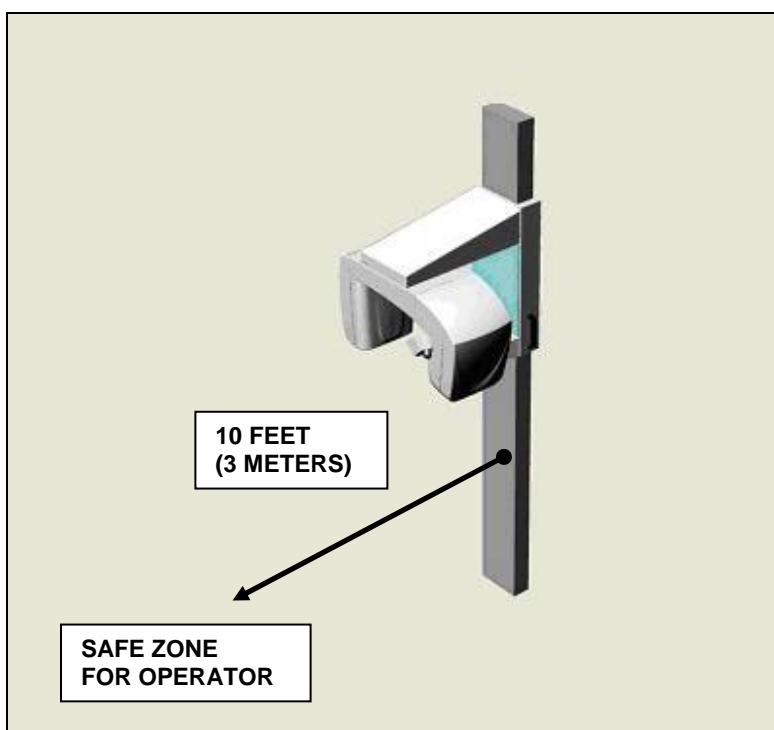

Figure 14. Operator Safety Zone

7. Using the iPan HS Upgrade Utility

7.1. Introduction

The iPan HS Upgrade Utility is installed during the iPan HS Interface Driver setup program. This tool can be used to accomplish the following:

- Perform USB diagnostic tests
- Perform USB Interface firmware upgrades
- Perform Sensor Module firmware upgrades`

A sample screen of the iPan HS Upgrade Utility is shown below. *(Please note that the version numbers shown in the picture below are examples only and may differ from those reported for your system.)*



Figure 15. iPan HS Upgrade Utility

The Refresh button on the utility can confirm the status of the system and can be useful before and after firmware upgrades. Clicking the Refresh button confirms that the iPan HS device is detected and can be used also to ensure that the CAT-5 cable is connected.

7.2. USB Interface Test

The iPan HS USB Interface Test checks the connection between the iPan HS USB Interface and the host computer. During this check, a gray test pattern is displayed, which should be reviewed for clarity and contrast.

A good test pattern will have a gradient pattern from black to white with gray rows between. A poor test pattern may have random and unrelated lines, other image artifacts, or may be completely blank and suggests a problem with the USB cable, USB port, or possibly the iPan HS USB Interface itself.

USB Interface Test Perform the following steps to start the USB Interface test procedure.

Step	Action
1	IMPORTANT! Close CDR DICOM, EagleSoft, or Patterson Imaging program (if running) before continuing with next step.
2	Verify that iPan HS USB Interface is connected to host computer.
3	Start the iPan HS Upgrade Utility.
4	Click Tools > USB Interface Test.

Example Note: After a momentary pause, a test pattern is displayed. The orange LED indicator on the iPan HS USB Interface blinks as the test pattern scrolls.

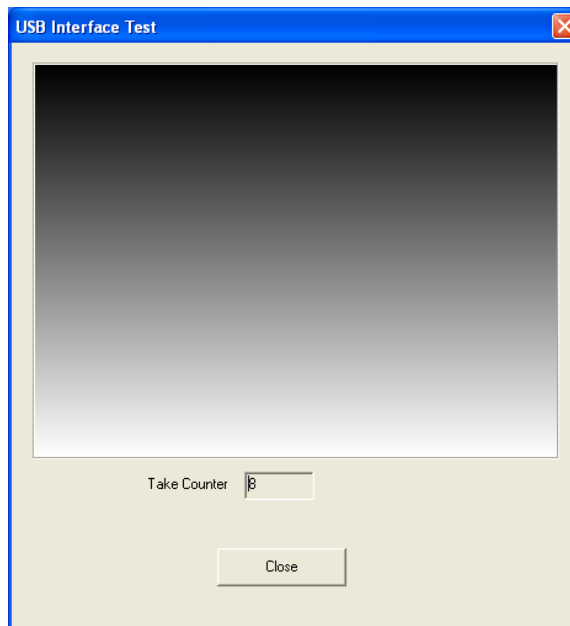

7.3. USB Interface Firmware Upgrade

Field updates to the iPan HS USB Interface can be accomplished by installing new firmware. When new firmware is available, it is typically provided with software releases and becomes part of the update to your existing system. In the event you are prompted to upgrade firmware, perform the steps provided below.

USB Interface Firmware Upgrade

Perform the following steps to start the USB Interface firmware upgrade procedure.

Step	Action
1	IMPORTANT! Close the CDR DICOM, EagleSoft, or Patterson Imaging program (if running) before continuing with next step.
2	Verify that iPan HS USB Interface is connected to host computer.
3	Start the iPan HS Upgrade Utility.
4	If the firmware version number is listed in red, click the Firmware Version button to upgrade.

Example

Pictured below is an example of the iPan HS Upgrade Utility, with the firmware upgrade button for the USB Interface highlighted.

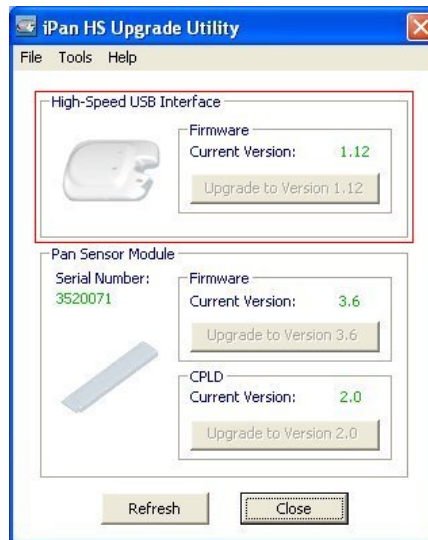

7.4. Sensor Module Firmware Upgrade

Field updates to the CDRPanX Sensor can be accomplished by installing new firmware. When new firmware is available, it is typically provided with software releases and becomes part of the update to your existing system. In the event you are prompted to upgrade firmware, perform the steps provided below.

Sensor Module Upgrade Perform the following steps to start the Sensor Module firmware upgrade procedure.

Step	Action
1	IMPORTANT! Close CDR DICOM, EagleSoft, or Patterson Imaging program (if running) before continuing with next step.
2	Verify that iPan HS USB Interface is connected to host computer.
3	Start the iPan HS Utility.
4	If the firmware version number is listed in red, click the Firmware Version button to upgrade.
5	If the CPLD version number is listed in red, click the CPLD Version button to upgrade.

Example Pictured below is an example of the iPan HS Upgrade Utility, with the firmware upgrade buttons for the Sensor Module highlighted.

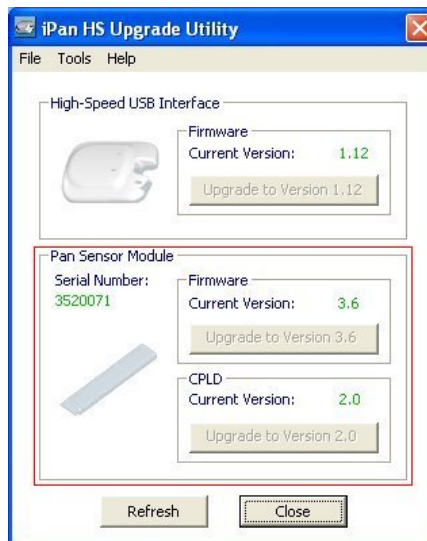

8. Cleaning

8.1. *CDRPanX Unit*

Observe the following precautions to perform cleaning procedures and to provide proper hygiene within the patient area.

- Before cleaning any part of the CDRPanX system, refer to the procedures in this document, or in the appropriate service guide, for proper turn off / power disconnection at the host panoramic machine.
- Use a soft, lint-free cloth when wiping exterior surfaces of the CDRPanX equipment. For stronger action, use a neutral soap to clean coated surfaces.
- Make sure that water or other liquids do not seep into the CDRPanX equipment, causing potential damage to internal, electrical, and mechanical components.
- Never use solvents (such as alcohol and Trichloroethylene), corrosive, or abrasive substances when cleaning.
- Clean and disinfect parts of the CDRPanX system that touch the patient.
- Clean any dust that may have accumulated in the output window of each laser source.

When the surfaces that were cleaned have dried sufficiently, connect and restore power to the system, following the turn-on procedures provided in this document or in the appropriate service guide.

8.2. *iPan HS USB Interface*

To clean the iPan HS USB Interface, apply a small amount of water or isopropyl alcohol (70%) to a non-abrasive, lint-free cloth. After cleaning, inspect the iPan HS USB Interface to ensure that all surfaces are clean and free of unwanted particles.

9. Maintenance

It is the responsibility of the user to maintain the equipment. Failure of the user to properly maintain the equipment may relieve the manufacturer, or its agent, from responsibility for any injury, damage, or non-compliance that may result.

9.1. Visual Inspection

Like all electrical equipment, the CDRPanX system requires not only correct use, but also visual inspection prior to operation, and routine checks at regular intervals. These precautions will help ensure that the CDRPanX equipment operates accurately, safely, and efficiently.

There are no user-serviceable components in the CDRPanX system. However, before operating the system, users shall check it for any signs of physical damage or defect. If detected, contact your local distributor of Schick Technologies products for further instructions.

9.2. Periodic Maintenance

Periodic maintenance is performed as needed, but at least once a month. It consists of various checks performed by the operator or by a qualified service technician. Always disconnect the main power supply before cleaning the system. Any defect or malfunction should be corrected immediately by qualified personnel with adequate training. Tasks to be performed regularly include the following:

- To clean CDRPanX parts and surfaces, use isopropyl alcohol (wiped or sprayed), or mild soap, taking care not to allow any liquid to seep into the equipment. Plastic covers can be wiped with a soft cloth and light detergent.
- To disinfect CDRPanX parts and surfaces that are in contact with the patient, use a detergent (for example, one containing 2% solution of ammonia). The bite block (but not the chin rest and the low and high chin templates) can be steam-sterilized by autoclave at 250°F (121°C).
- To disinfect CDRPanX parts and surfaces, use a solution of 70% ethanol as an active ingredient. After the appropriate surfaces have been disinfected, they may be wiped with isopropyl-soaked wipes / napkins.
- Check all cables, any cables in deteriorated condition should be replaced.



WARNING: Any defective item affecting the safe use of CDRPanX equipment must be repaired or replaced immediately. Refer to the CDRPanX Service and Installation Guide for general service information and specific procedures for repair and / or replacement.

9.3. Scheduled Maintenance

Qualified personnel must perform maintenance of the equipment at least once a year.

- Complete check of system performance (kV, mA).
- Check proper working condition of all mechanical and electrical safety features.
- Lubrication of accessible parts.
- Specific lubrication of movable parts has to be done at least every two years of operation.
- Check that the labels are intact, readable, and adhere well to the surfaces on which they are positioned.
- Check that all of the cables that connect equipment in the CDRPanX system are undamaged.
- Check that there is no external damage to the CDRPanX equipment which could compromise its ability to operate safely and to provide the proper emission of X-rays.
- Check the operation of the audible alarm during normal operation.

Appendix A. Error Codes

Table 6. Control Panel Error Codes

Code	Description
1	Microprocessor error
2	EPROM error
4	RAM error
7	Rotation unit cannot move: stepper motor control error
11	Digital imaging software not ready to acquire image
12	Invalid limit switch status
13	Exposure exceeds maximum time permitted
14	X-ray high voltage error
15	Undervoltage condition at main power
17	Tube filament heating current exceeds range permitted
18	No current in X-ray tube
19	Exposure switch released during exposure time: incomplete image
20	Exposure switch released prior to X-ray emission: exposure was unsuccessful
21	Exposure switch released after X-ray emission, but rotation motor movement was not complete
23	Rotation unit steps do not match in half of the track
25	Rotation unit steps do not match in half of the track
28	Rotation unit steps do not match at the end of the track
31	Rotation unit does not move
33	Tube filament heating current active during off status
34	X-ray tube current active during off status
60	Control unit microcontroller or memory error
62	Software error while Rotation unit is in motion
63	Tube head temperature exceeds value permitted
64	15V power supply error
65	24V power supply error
66	5V power supply error

Please Note: The table above describes error codes that appear when the Error indicator on the Control Panel is illuminated. For service codes, refer to the CDRPanX Service and Installation manual.

Appendix B. Technical Data

Table 7. Summary of CDRPanX Technical Data

Item	Description
IEC Classification	Class I, type B
Power Supply	230V, 50/60 Hz, 8 A 115V, 50/60 Hz, 16 A
Mains Resistance	< 2 ohm at 230V
X-ray Generator	Multipulse at 20 kHz
Time Accuracy	± 5%
kV Accuracy	± 5%
X-ray Tube Current (mA)	± 5%
Anode Voltage	60 - 86 kV, Constant Potential
Anode Current	4 - 10 mA, Direct Current
Focus Size	0.5 IEC 336
Inherent Filtration	0.098 in (2.5 mm) Al
Column Height	7.68 ft (234 cm)
Displacement	3.05 ft (93 cm), from 2.9 ft to 5.95 ft (88.5 to 181.5 cm)
Vertical Movement	Manual Adjustment
Patient Positioning	Manual Carriage Adjustment
Positioning Lasers	Lateral, mid-sagittal, frankfort
Centering Reference	Chin rest with bite stick
Focus Film Distance	1.67 ft (51 cm)
Exposure time	19 s
Projections	Adult (19 s) Children (15 s) Half Left (10 s) Half Right (10 s) Frontal Teeth (8 s) TMJ opened and closed mouth (4 x 4 s) Frontal Sinuses (19 s)
Cooling Pause	Automatically controlled, 6 minutes maximum
Weight	540 lbs (245 kg)

Table 8. Compliance Specifications

Item	Description
CAN/CSA C22.2 No.601.1-M90	Medical Electrical Equipment Part 1: General Requirements for Safety
UL60601-1	Medical Electrical Equipment Part 1: General Requirements for Safety

Item	Description
EC 93/42/EEC	Medical Device Directive
IEC60601-1	Medical Electrical Equipment Part 1: General Requirements for Safety
IEC60601-1-2	Medical Electrical Equipment Part 1: General Requirements for Safety 2.Collateral Standard: Electromagnetic Compatibility – Requirements and Tests
EN 60601-1-3	Medical Electrical Equipment. Part 1: General requirements for safety. 3 - Collateral Standard: General requirements for radiation protection in diagnostic X-ray equipment
EN 60601-2-7	Medical Electrical Equipment. Part 2: Particular requirements for the safety of high voltage generators of diagnostic X-ray generators
EN 60601-2-28	Medical Electrical Equipment. Part 2: Particular requirements for the safety of X-ray source assemblies and X-ray tube assemblies for medical diagnosis

Table 9. Guidance and Manufacturer's Declaration - Electromagnetic Emissions

PLEASE NOTE: The CDRPanX system is intended for use in the electromagnetic environment specified below. The customer or user of the CDRPanX system must ensure that it is used in such an environment.

Emissions Test	Compliance	Electromagnetic Environment
RF emissions CISPR 11	Group 1	The CDRPanX system is suitable for use in domestic establishments and in establishments directly connected to the low-voltage power supply network that supplies buildings used for domestic purposes.
RF emissions CISPR 11	Class B	
Voltage fluctuations/ flicker emissions IEC 61000-3-3	Complies	
Harmonic Emissions IEC 61000-3-2	Not applicable	

Table 10. Guidance and Manufacturer's Declaration - Electromagnetic Immunity

PLEASE NOTE: The CDRPanX system is intended for use in the electromagnetic environment specified below. The customer or user of the CDRPanX system must ensure that it is used in such an environment.

Immunity Test	IEC 60601-1-2 Test Level	Compliance Level	Electromagnetic Environment
Electrostatic discharge (ESD) IEC 61000-4-2	±6 kV contact ±8 kV air	±6 kV contact ±8 kV air	Floors should be wood, concrete or ceramic tile. If floors are covered with synthetic material, the relative humidity should be at least 30%

Immunity Test	IEC 60601-1-2 Test Level	Compliance Level	Electromagnetic Environment
Electrical fast transient/burst IEC 61000-4-4	±2 kV for power supply lines ±1 kV for input/output lines	±2 kV for power supply lines ±1 kV for input/output lines	Mains power quality should be that of a typical commercial or hospital environment.
Surge IEC 61000-4-5	± 1 kV Line(s) to Line(s) ± 2kV Line(s) to earth	± 1 kV Line(s) to Line(s) ± 2kV Line(s) to earth	Mains power quality should be that of a typical commercial or hospital environment.
Voltage dips, short interruptions and voltage variations on power supply input lines IEC 61000-4-11	< 5% U_T (>95% dip in U_T) for 0.5 cycle 40% U_T (60% dip in U_T) for 5 cycles 70% U_T (30% dip in U_T) for 25 cycles < 5% U_T (>95% dip in U_T) for 5 sec	< 5% U_T (>95% dip in U_T) for 0.5 cycle 40% U_T (60% dip in U_T) for 5 cycles 70% U_T (30% dip in U_T) for 25 cycles < 5% U_T (>95% dip in U_T) for 5 sec	Mains power quality should be that of a typical commercial or hospital environment. If the user of the CDRPanX system requires continued operation during mains interruptions, it is recommended that the CDRPanX system be powered from an uninterruptible power supply or battery. NOTE: U_T is the AC mains voltage prior to application of the test level.
Power frequency (50/60 Hz) magnetic field IEC 61000-4-8	3A/m	3A/m	Power frequency magnetic fields should be at levels characteristic of a typical location in a typical commercial or hospital environment.
Conducted RF IEC 61000-4-6	3 Vrms 150 kHz to 80 MHz	3 Vrms	Portable and mobile RF communication equipment should be used no closer to any part of the CDRPanX system, including its cables, than the recommended separation distance calculated from the equation applicable to the frequency of the transmitter. Recommended separation distance: $d = 1.2\sqrt{P}$ $d = 1.2\sqrt{P}$ for 80 MHz to 800 MHz $d = 2.3\sqrt{P}$ for 800 MHz to 2.5 GHz Where P is the maximum output rating of the transmitter in watts (W) according to the transmitter manufacturer and d is the recommended separation in meters (m).
Radiated RF IEC 61000-4-3	3 V/m 80 MHz to 2.5 GHz	3 V/m	

Immunity Test	IEC 60601-1-2 Test Level	Compliance Level	Electromagnetic Environment
			<p>Field strengths from fixed RF transmitters, as determined by an electromagnetic site survey,^a should be less than the compliance level in each frequency range.^b</p> <p>Interference may occur in the vicinity of equipment marked with the following symbol.</p> 
NOTE 1: At 80 MHz and 800 MHz, the higher frequency range applies.			
NOTE 2: These guidelines may not apply in all situations. Electromagnetic propagation is affected by absorption and reflection from structures, objects and people			
<p>^a Field strengths from fixed transmitters, such as base stations for radio (cellular/cordless) telephones and land mobile radios, amateur radio, AM and FM radio broadcast and TV broadcast cannot be predicted theoretically with accuracy. To assess the electromagnetic environment due to fixed RF transmitters, an electromagnetic site survey should be considered. If the measured field strength in the location in which the CDRPanX System is used exceeds the applicable RF compliance above, the CDRPanX System should be observed to verify normal operation. If abnormal performance is observed, additional measures may be necessary, such as reorienting or relocating the CDRPanX System.</p> <p>^b Over the frequency range 150 kHz to 80 MHz, field strengths should be less than 3 V/m.</p>			

Table 11. Recommended Separation Distance Between Portable and Mobile RF Communications Equipment and the CDRPanX System

PLEASE NOTE: The CDRPanX System is intended for use in an electromagnetic environment in which radiated RF disturbances are controlled. The customer or user of the CDRPanX System can help prevent electromagnetic interference by maintaining a minimum distance between portable and mobile RF communications equipment (transmitters) and the CDRPanX System as recommended below, according to the maximum output power of the communications equipment.

Rated maximum output power of the transmitter (W)	Separation distance according to the frequency of the transmitter (m)	
	150 kHz to 800 MHz $d = 1.2\sqrt{P}$	800 MHz to 2.5 GHz $d = 2.3\sqrt{P}$
0.01	0.12	0.23
0.1	0.38	0.73
1	1.2	2.30
10	3.8	7.3
100	12.0	23.00
<p>For transmitters rated at a maximum output power not listed above, the recommended separation distance d in meters (m) can be estimated using the equation applicable to the frequency of the transmitter, where P is the maximum output power rating of the transmitter in watts (W) according to the transmitter manufacturer.</p> <p>NOTE 1: At 800 MHz, the separation distance for the higher frequency range applies.</p> <p>NOTE 2: These guidelines may not apply in all situations. Electromagnetic propagation is affected by absorption and reflection from structures, objects, and people.</p>		

Appendix C. Cooling Curves

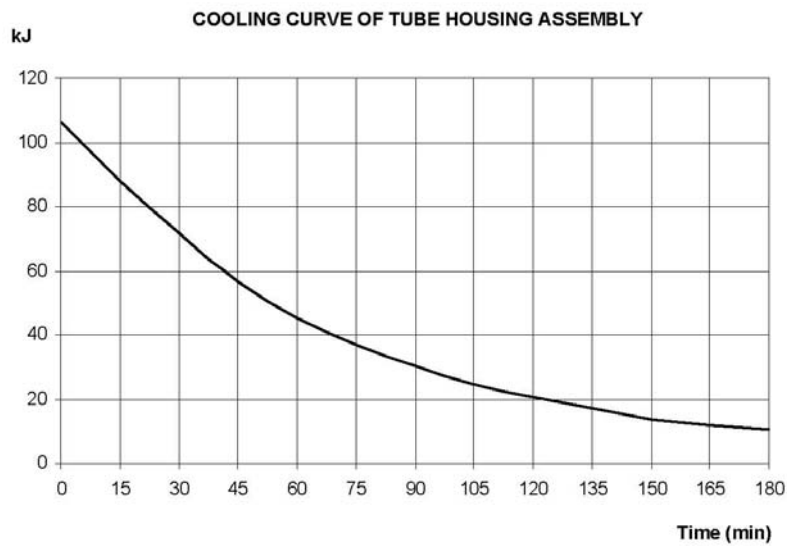
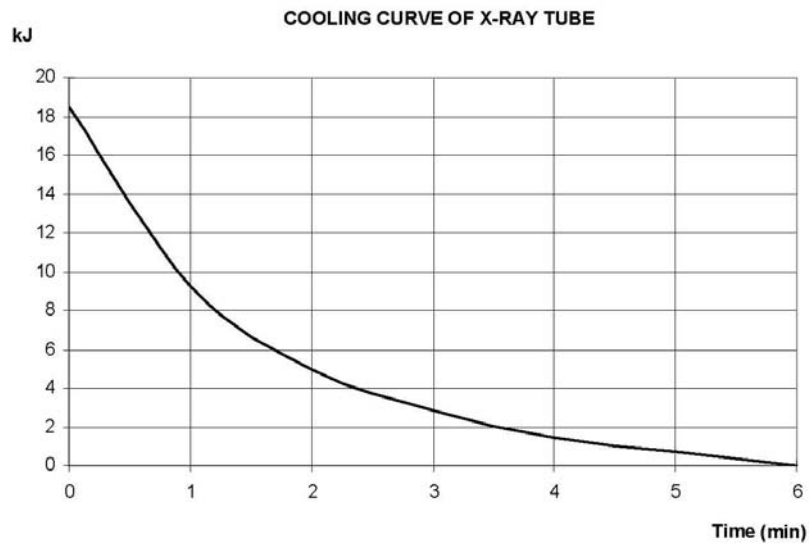

Index

A

Anode Current Setting, 10

C

CDR DICOM System

Installation Requirements for, 13

CDRPanX

Control Panel, 6

Control Unit, 8

Cooling Curves, 44

General Information, 3

Indications for Use, 1

Installation, 13

Introduction, 1

Maintenance, 37

Operation, 20

Purpose and Features, 1

Ready/Not Ready Indications, 20

System Description, 3

System Operation, 3

Technical Data, 40

Turn Off, 21

Turn On, 20

CDRPanX Control Panel

Picture of, 6

CDRPanX Principal Units

Picture of, 4

CDRPanX System

Electromagnetic Emissions, 41

Electromagnetic Immunity, 41

Recommended Separation Distance Between
Portable and Mobile RF Communications
Equipment, 43

Specifications, 40

Control Panel, 6

Error Codes, 39

Table Describing, 6

Control Unit, 8

Anode Current Setting, 10

Exposure, 10

High Voltage Setting, 10

Monitoring During Exposure, 10

Reset for Next Exposure, 10

Setup for Exposure, 8

Controls and LED Indicators, 18

Cooling Curves, 44

D

Dedicated Host Computer, vi

Do Not Touch Exposed Connectors, vi

E

Ensure CDRPanX-C System Operates Optimally, v

Error Codes, 39

Table Describing, 39

Error Handling, 11

Exposure, 10

Exposure Switch

Table Describing, 8

F

Federal Law Restriction for Sale, iv

Focal Trough Adjustments

Pictures of, 27

H

High Voltage Setting, 10

I

Indicators, 18

Installation, 13

iPan HS Upgrade Utility, 32

Picture of, 32

Sensor Module Upgrade, 35

USB Interface Test, 33

USB Interface Upgrade, 34

iPan HS USB Interface

Indicators, 18

Picture of, 18

Table of Indicators, 19

iPan HS USB Interface Driver

Installation, 13

L

Laser Alignment Beams

Frankfort Plane, 11

Lateral Plane, 11

Mid-Sagittal Plane, 11

LEDs, 18

iPan HS USB Interface, 18

M

Maintenance

Periodic, 37

Scheduled, 38

Maxillary Sinuses, 29

Picture of, 30

Monitoring During Exposure, 10

N

Notice
Installers, 1
Users, 2

O

Operator
Location of Safety Zone, 31
Positioning, 31

P

Panoramic Imaging, 22
Exposures, 31
Maxillary Sinus Program, 29
Patient Positioning, 23
Projections and Techniques, 22
TMJ Program, 28
Panoramic Imaging Areas
Picture of, 1
Panoramic Projections, 10, 22
Patient Positioning, 23
Steps for Maxillary Sinuses Projection, 29
Steps for Panoramic Exam, 23
Steps for TMJ Projection, 28
Preventive Maintenance, v
Purpose and Features of CDRPanX, 1

R

Ready/Not Ready Indications, 20
Requirements, 13
Reset for Next Exposure, 10
Reset Function, 11
RF Interference, iv

S

Safety Issues
Dedicated Host Computer, vi
Do Not Touch Exposed Connectors on Non-Medical Equipment and the Patient at the Same Time, vi
Ensure CDRPanX-C System Operates Optimally, v
Preventive Maintenance, v
Restriction for Sale, iv
RF interference, iv
Sensor Module Upgrade, 35
Setup for Exposure, 8
Summary of Technical Data, 40

T

Technical Data, 40
Table Summarizing, 40
Technique Factors, 22
TMJ
Picture of, 30
Projections, 28
Turning Off the CDRPanX System, 21
Turning On the CDRPanX System, 20

U

USB Interface Test, 33
USB Interface Upgrade, 34

V

Voltage and Current Settings
Table Describing, 22

W

Waste Electrical and Electronic Equipment (WEEE),
xii